

J. H. FLETCHER & CO. Box 2187 – Huntington, WV 25722-2187 – 304/525-7811 – FAX 304/525-4025

IMPORTANT SAFETY NOTICE

INFORMATION BULLETIN NO. 97

TO:	OWNERS OF MODEL DDO/LTDO ROOF BOLTERS
FROM:	J.H. FLETCHER & CO.
DATE:	APRIL 2005
SUBJECT:	FEED CYLINDER PIN RETAINER CAP

On January 31, 2005 a roof bolter operator was injured at a mine in West Virginia. The Mine Safety and Health Administration (MSHA) is still conducting its investigation.

Preliminary information obtained by J.H. Fletcher & Co. (Fletcher) indicates that the operator using a Fletcher DDO roof-bolting machine was injured when the boom fell and the operator had his leg under the boom area. It is reported that the boom fell because the cap that holds the feed cylinder pin in place had broken loose (see Attachment 1).

Fletcher is sending out this bulletin to remind all owners and operators of specific arm feed machines (DDO/LTDO roof bolters only) of the previously published warnings about the open and obvious pinch point dangers inherent in a roof bolting machine; the essential requirement that an operator never position any portion of his/her body in the pinch point area; the possibility of severe injury or death that could occur if these warnings are ignored; the importance of using only OEM components and proper maintenance of all equipment.

There are numerous pinch point areas on a roof bolter. The area between the boom and the mine floor or roof is an open and obvious pinch point area. No body part should ever be in this space. Placing any body part in a pinch point area could result in serious injury or death. Fletcher recommends that you discuss pinch point areas at your next safety meeting and display the enclosed posters (part no. 359305) at numerous locations at the mine site. Re-instruct your operators of the need to keep a safe distance from all moving parts and to maintain all guards, warning labels and tags on the machine at all times.

Second, Fletcher strongly recommends the use of OEM components. OEM components meet Fletcher's design and manufacturing specifications. Materials used to manufacture OEM components, such as the feed cylinder cap and its hardware, are selected especially for these roof bolters. Failure to use OEM components could result in serious injury or death due to the use of improper or substandard parts.

Last, the roof-bolting machine should be inspected regularly, as instructed in the operator's manual. Any necessary maintenance or repairs must be done before operating the machine again. As stated above, it is reported that the cap used to hold the feed cylinder pin in place broke. The cap (P/N: 82578) for this particular machine is illustrated in the parts book as a replacement part. **The cap must be inspected regularly to ensure that it does not become loose.** In order to do this, maintenance personnel must refer to Attachment 2. A chart like the one in your service manual that shows the recommended torque for all bolts is enclosed for your reference (see Attachment 3).

J.H. Fletcher & Co. has made this component part of a kit (P/N: 393986) that includes all the necessary parts and information to perform the maintenance/replacement of the feed cylinder pin retainer cap correctly. You may contact Fletcher or one of its authorized distributors to order the kit.

This issue affects only the types of machines we have identified in this bulletin. If you have any questions about this bulletin or any other safety issues please call the J.H. Fletcher & Co. Risk Management Department at 304-525-7811.

ATTACHMENT 1

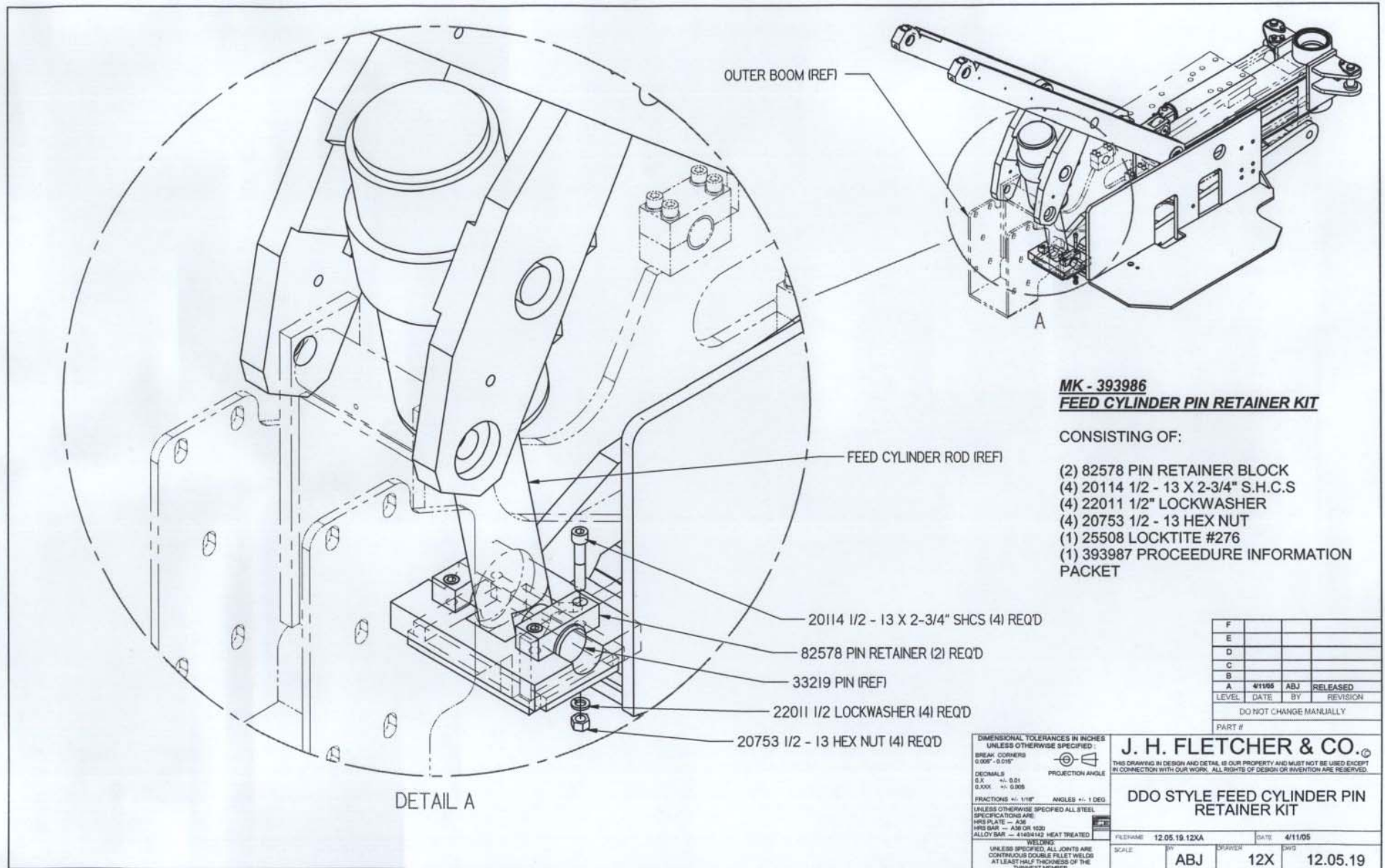

MK - 393986
FEED CYLINDER PIN RETAINER KIT

CONSISTING OF:

- (2) 82578 PIN RETAINER BLOCK
- (4) 20114 1/2 - 13 X 2-3/4" S.H.C.S
- (4) 22011 1/2" LOCKWASHER
- (4) 20753 1/2 - 13 HEX NUT
- (1) 25508 LOCKTITE #276
- (1) 393987 PROCEEDURE INFORMATION PACKET

F			
E			
D			
C			
B			
A	4/11/05	ABJ	RELEASED
LEVEL	DATE	BY	REVISION
DO NOT CHANGE MANUALLY			
PART #			

DIMENSIONAL TOLERANCES IN INCHES
 UNLESS OTHERWISE SPECIFIED
 BREAK CORNERS
 0.005" - 0.015"
 DECIMALS
 0.1 ±0.01
 0.001 ±0.0005
 FRACTIONS ±0.1/100" ANGLES ±1 DEG
 UNLESS OTHERWISE SPECIFIED ALL STEEL
 SPECIFICATIONS ARE
 WRS PLATE - A36
 WRS BAR - A36 OR 1020
 ALLOY BAR - 4140/4142 HEAT TREATED
WELDING
 UNLESS SPECIFIED, ALL JOINTS ARE
 CONTINUOUS DOUBLE FILLET WELDS
 AT LEAST HALF THICKNESS OF THE
 THINNEST MEMBER

J. H. FLETCHER & CO.
 THIS DRAWING IN DESIGN AND DETAIL IS OUR PROPERTY AND MUST NOT BE USED EXCEPT
 IN CONNECTION WITH OUR WORK. ALL RIGHTS OF DESIGN OR INVENTION ARE RESERVED.

**DDO STYLE FEED CYLINDER PIN
 RETAINER KIT**

FILENAME: 12.05.19.12XA DATE: 4/11/05
 SCALE: BY ABJ SUPPLIER: 12X PWS: 12.05.19



SERVICE MANUAL

TABLE OF CONTENTS:

[SAFETY](#)

[LUBRICATION](#)

[ROUTINE
MAINTENANCE](#)

[ELECTRICAL
SYSTEM](#)

[HYDRAULIC
SYSTEM](#)

[DUST SUPPRESSION
SYSTEM](#)

[FIRE SUPPRESSION
SYSTEM](#)

[TOWING](#)

[MAIN](#)

DEPENDING ON THE BOOM DESIGN OF YOUR SPECIFIC MACHINE, BLOCKING CAN BE DONE BY CRIBBING OR BY THE USE OF A BOOM LOCKING PIN. A DESCRIPTION OF BOTH METHODS FOLLOWS:

This machine is composed of several permissible and certified systems (electrical system, dust suppression system, canopies and ATRS). In order to maintain permissibility and certification, the repair and replacement parts used in these permissible and certified systems must meet exact OEM specifications. The best means of assuring that these parts meet these specifications is by utilizing only genuine Fletcher OEM repair and replacement parts.

BLOCKING

Blocking must be utilized whenever there is the possibility of getting any part of your body caught between or in a pinch point area. Never depend upon a hydraulic cylinder to maintain working clearance. A ruptured hose, removing a fitting or valve cartridge or operation of a control valve (even with the machine shut down), could cause an unexpected movement.



This warning tag has been installed on the machine to remind you to install blocking prior to performing maintenance, repair or inspection.



WARNING

CRUSHING HAZARD

Boom may fall suddenly.

Can cause severe injury or death.

Fully lower or securely block all moving parts and
Lock out power before performing maintenance.

J.H. FLETCHER & CO.

PART NO. 326070

On Fletcher arm feed style roof drills, the drill boom presents a pinch point or caught between potential. Whenever working in this area, always use blocking.

There are three methods of making the drill boom area safe:

1 – Fully lower the drillhead against the floor.





SERVICE MANUAL

TABLE OF CONTENTS:

[SAFETY](#)

[LUBRICATION](#)

[ROUTINE MAINTENANCE](#)

[ELECTRICAL SYSTEM](#)

[HYDRAULIC SYSTEM](#)

[DUST SUPPRESSION SYSTEM](#)

[FIRE SUPPRESSION SYSTEM](#)

[TOWING](#)

[MAIN](#)

2 – Place blocking (crib) between the drillhead and the floor.



3 – Use the boom locking pin.

The boom locking pin is located under the rubber guard on the top of the boom – as shown in the photo below.

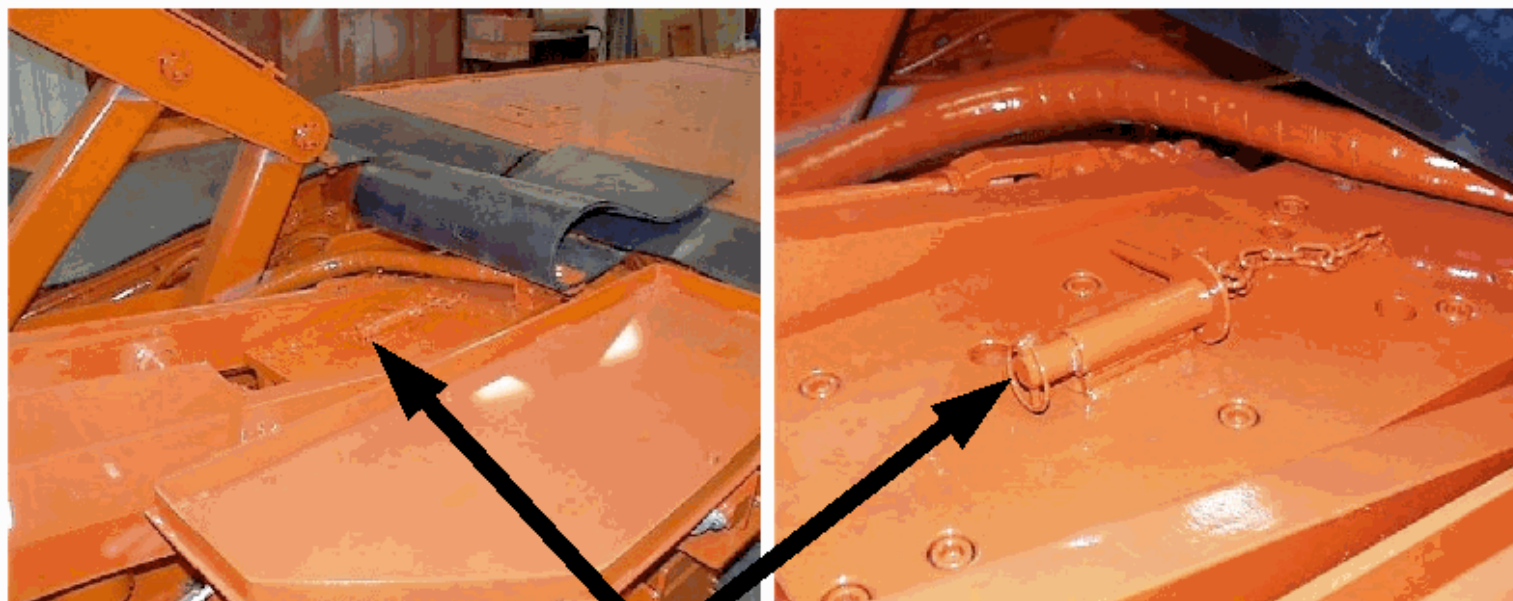

Boom Pin Location



SERVICE MANUAL

TABLE OF CONTENTS:

[SAFETY](#)

[LUBRICATION](#)

[ROUTINE MAINTENANCE](#)

[ELECTRICAL SYSTEM](#)

[HYDRAULIC SYSTEM](#)

[DUST SUPPRESSION SYSTEM](#)

[FIRE SUPPRESSION SYSTEM](#)

[TOWING](#)

[MAIN](#)

To use the boom locking pin: raise the drillhead, insert the pin into the hole in the plate, then lower the drillhead until the roller assembly is resting against the pin. See photos below:



Insert Pin Into Hole



Lower Drillhead Until Roller Assembly's Resting Against Pin

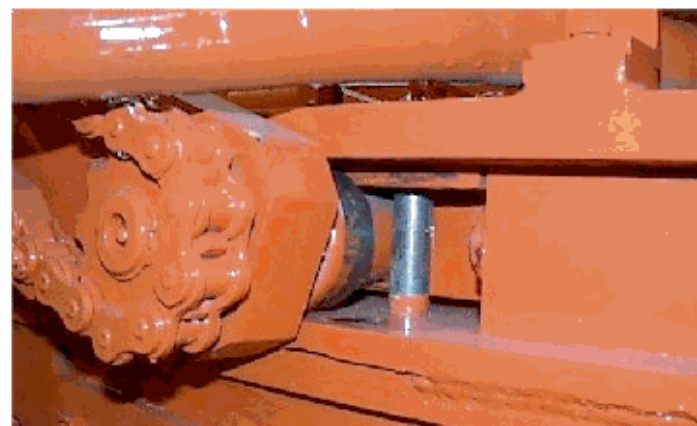



SERVICE MANUAL

TABLE OF CONTENTS:

[SAFETY](#)

[LUBRICATION](#)

[ROUTINE MAINTENANCE](#)

[ELECTRICAL SYSTEM](#)

[HYDRAULIC SYSTEM](#)

[DUST SUPPRESSION SYSTEM](#)

[FIRE SUPPRESSION SYSTEM](#)

[TOWING](#)

[MAIN](#)

Regardless of the method of blocking used, always fully lower the load against the blocking and release the pressure in the circuit by operating the DRILL FEED control in both directions with the machine shut down.



Finally, remove the power to the machine at the power center, tag and lock out.

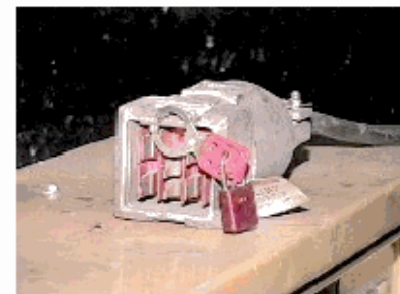

TIGHTENING TORQUE RECOMMENDATIONS

Bolts and cap screws on new and rebuilt machines, after working under load, tend to “set” or to conform to the assembly, causing them to lose some of their initial tension. This is especially true of gasket joints, since the gaskets season and shrink under load and temperature. Consequently, to assure trouble-free operation, cap screws and bolts should be checked for tightness after the first few shifts of operation and **repeated frequently until no further loosening occurs. After this, checks done once every one to six months should be enough.** Specific tightening torques should be maintained where instructed. A joint that is allowed to remain loose for a period of time may not be tightened again with the same success as before. Standard tightening torque recommendations are shown in the following table:

	NOTE: TORQUES ARE IN FT. POUNDS	Grade 5 hex head cap screw	Grade 8 hex head cap screw	Socket Head Cap Screw
	CAP SCREW SIZE			
Coarse Thread	1/4 – 20	10	14	14
	3/8 – 16	36	50	50
	1/2 – 13	90	125	125
	5/8 – 11	175	240	240
	3/4 – 10	310	430	430
	7/8 – 9	500	700	700
	1 – 8	740	1050	1050
	1 1/8 – 7	930	1320	1320
	1 1/4 – 7	1300	1845	1845
	1 1/2 – 6	2270	3222	3222
Fine Thread	1/4 – 28	11	15	15
	3/8 – 24	40	60	60
	1/2 – 20	100	140	140
	5/8 – 18	200	280	280
	3/4 – 16	340	480	480
	7/8 – 14	550	770	770
	1 – 14	810	1150	1150
	1 1/8 – 12	1040	1477	1477
	1 1/4 – 12	1440	2045	2045
	1 1/2 – 12	2550	3621	3621

Hexagon Head cap screws are recognized by markings found on the head as shown.

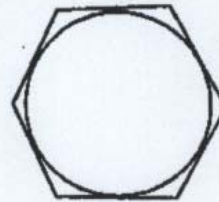

Grade No. 2 or ordinary Cap Screws - No marking on the head. (Not heat-treated)

* Not used on JHF machines

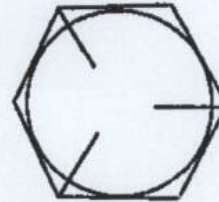

Grade No. 5 Cap Screws - 3 Radial dashes on the head. (Heat Treated)

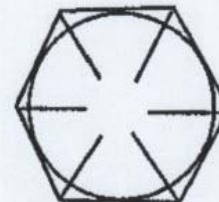

Grade No. 8 Cap Screws - 6 Radial dashes on the head. (Heat treated)

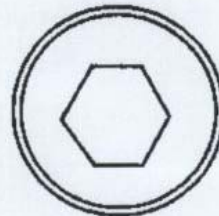

Socket Head Cap Screws (Heat-treated)

Corrosion resistant plating applied to the fastener acts as a lubricant. When plated fasteners are used, tightening torques should be reduced by approximately 25 percent

Torque values are for dry threads. If threads are lubricated, tightening torques should be reduced approximately 25 percent

* General formula for calculating torque.
 Torque (in. – lb) = 0.2 x normal diameter of screw x load (b) where load is 80% of yield strength expresses in pounds, not psi. Torque for bolts with nuts may be slightly higher.